

# **YSS** High Quality Plastic Mold Steels HI-PM Series

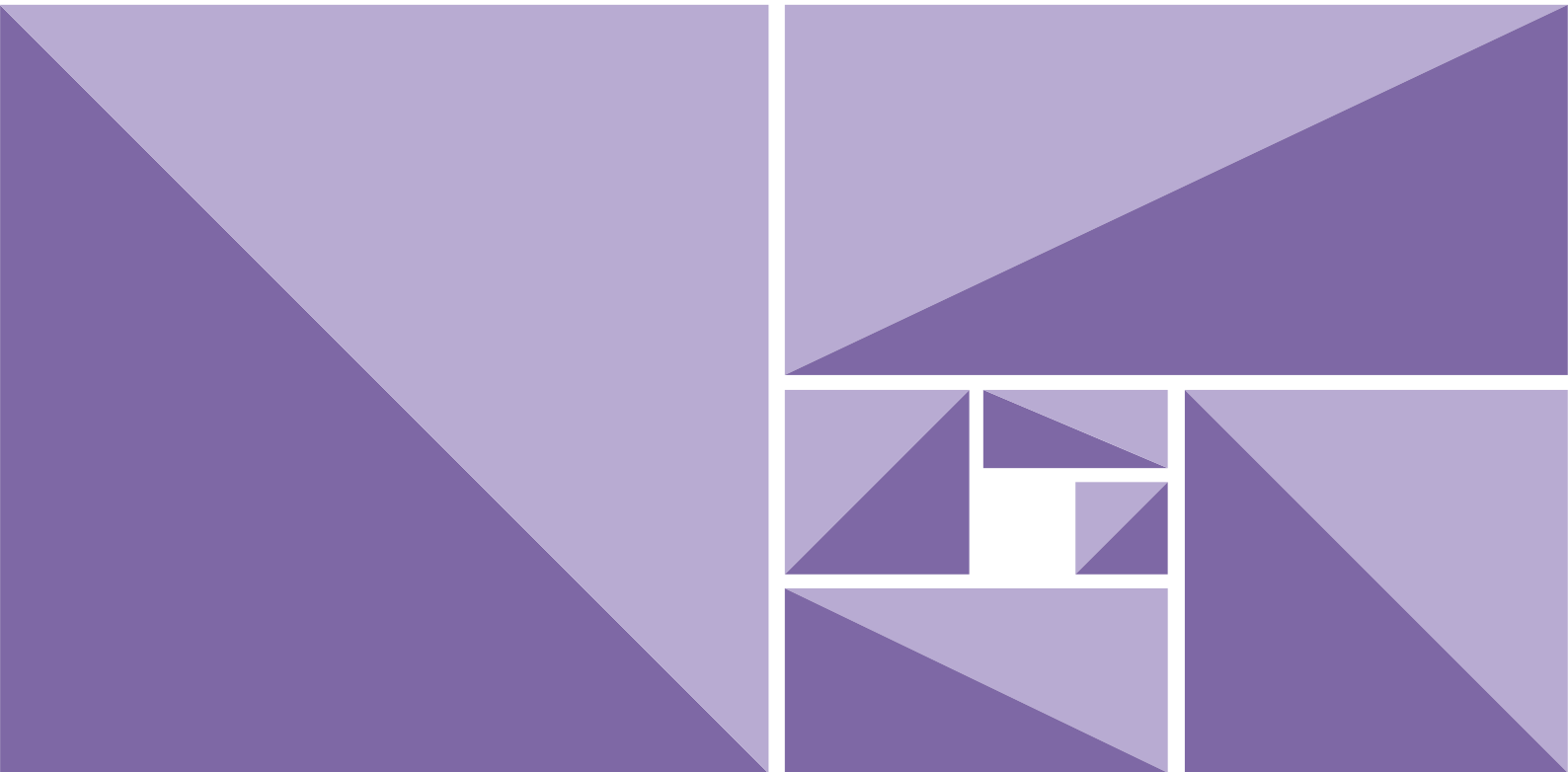

# Mold Material and Application

Group	Hardness Employed (HRC)	Grade	Material Type	Application Example
Prehardened	29 - 33	<b>HI-PM7</b>	P20 improved	Mold required good weldability and machinability (Autoparts, Home electronics, House equipment)
		<b>HI-PM38</b>	420 improved	Flame retardant resin, Transparent parts, Rubber
		<b>HI-PM77</b>	420 improved and resulphurized	Corrosion resistant mold bases, Rubber mold
	(Round Bar) 38 - 42 (Flat Bar) 33 - 37	<b>PSL</b>	630 improved	Mold for polyvinyl chloride, Frothy resin, Rubber
	37 - 42	<b>CENA1</b>	Cr contained NiAl precipitation grade	Rust resistant mold with sensitive surface as mirror polishing, creping, EDM, Weldless Mold
	37 - 41	<b>HI-PM MAGIC</b>	P20 improved	General Mass-Production Mold (Autoparts, OA equipment, Home Electronics)
		<b>HI-PM PRO</b>	P21 improved	Parts associated with automobile headlamp production, Exterior of cellular phone
		<b>HI-PM1</b>	P21 improved and resulphurized	Mold for general use (Home electronics etc), Plate and holder
	38 - 42	<b>FDAC</b>	H13 improved and resulphurized	Engineering resin, Slide core
	For Quench and Temper	50 - 55	<b>HI-PM38</b>	420 improved
<b>HI-PM38S</b>			420 improved	Mold for super mirror polish (Optical disc / Aspheric lens)
56 - 62		<b>HI-PM31</b>	D2 improved	Wear resistant mold for engineering resin (Gear, Connector, IC)
		<b>HAP5R</b>	P/M HSS	Mold required high toughness and high hardness (Core pin, Thin wall)
60 - 63		<b>ZCD-M</b>	D2 improved	IC mold
60 - 65		<b>ZDP4</b>	P/M Cold Die Steel	Reinforced and flame retardant engineering resin, IC mold, Slide parts, Cutter required exceptional wear resistance
For Aging	35 - 45	<b>HI-PM75</b>	High hardness, non-magnetic, resulphurized	Molding in magnetic field (Plastic magnet)
	52 - 57	<b>YAG</b>	Maraging Steel	Mold required exceptional toughness (Core pin, Thin wall), Super mirror polish (Optical lens)



<Attention> The characteristics, photos, charts, rankings and evaluations of this catalog are representative value by our test data, it does not guarantee the quality of the product. This catalog and its contents are subject to change without notice.

## Resin Types and Grade Selection

Resin		Required Properties for Mold	Required Life and Grade Recommended			
			SHORT <100,000	MEDIUM <500,000	LONG <1,000,000	MASS PRODUCTION >1,000,000
Thermo-plastic	General	Machinability	HI-PM7	HI-PM7 HI-PM MAGIC CENA1 HI-PM PRO	HI-PM MAGIC CENA1 HI-PM PRO FDAC	HI-PM MAGIC FDAC ) + Nitriding
	Engineering Resin	Wear Resistivity	HI-PM7	HI-PM7 HI-PM MAGIC FDAC ) + Nitriding	HI-PM MAGIC FDAC ) + Nitriding	HI-PM38 HI-PM31
	Reinforced	High Wear Resistivity	HI-PM MAGIC HI-PM PRO FDAC, HI-PM1	HI-PM MAGIC FDAC ) + Nitriding Plating	HI-PM31	HI-PM31 + Plating ZDP4 HAP5R, HAP40
	Flame Retardant	Corrosion Resistivity	HI-PM38 (Prehardened) CENA1	HI-PM38 PSL	HI-PM38	HI-PM38 + Plating
	Transparent	Mirror Polishability	CENA1	CENA1 HI-PM38	HI-PM38	HI-PM38
Thermo-set	General	Wear Resistivity	HI-PM MAGIC HI-PM PRO FDAC, HI-PM1	HI-PM MAGIC HI-PM PRO ) + Plating FDAC	HI-PM31	HI-PM31
	Reinforced	High Wear Resistivity	HI-PM MAGIC FDAC ) + Nitriding	HI-PM31	HI-PM31 ZCD-M ) + Plating	ZDP4 + Plating

General Resin : PS, PE, PP, AS, ABS etc.

Engineering Resin : PC, PPE, PA, POM, PBT, PET etc.

Advanced Engineering Resin : PPS, PI, PES, PEEK etc.

## Properties Comparison Table

Material	Machinability	Dimensional change by heat treatment	EDM/Creping texture	Mirror polishability	Weldability	Rust resistance	Wear resistance	Toughness	Cost
HI-PM7	A	-	C	C	A	D	D	B	B
HI-PM77	B	-	D	D	C	B	D	C	C
PSL	D	-	B	C	A	A	D	B	D
CENA1	C	-	A	B	C	C	D	C	D
HI-PM MAGIC	B	-	B	C+	A	D	D	B	C
HI-PM PRO	B	-	A	B	B	D	D	C	D
HI-PM1	A	-	D	D	D	D	D	D	C
FDAC	C	-	D	D	C	D	C	C	C
HI-PM38	C	A	A	A	C	B	C	C	D
HI-PM38S	C	A	A	A+	C	B	C	C	E
HI-PM31	C	B	A	B	D	C	B	C	D
HAP5R	C	C	A	B	D	E	B	B	E
ZCD-M	D	C	A	D	E	C	B	D	D
ZDP4	E	D	B	B	E	C	A	E	E
HI-PM75	E	B	D	D	E	B	C	C	E
YAG	D	B	A	A	A	D	C	A	E
S55C	A	-	C	E	C	E	E	C	A
SCM440	C	-	C	D	D	D	D	C	B

Ratings : A--Best C--Ordinary D, E--Poor

(Remarks) Please refer above as general concept.



<Attention> The characteristics, photos, charts, rankings and evaluations of this catalog are representative value by our test data, it does not guarantee the quality of the product. This catalog and its contents are subject to change without notice.

# Properties Comparison

## Polishing Property (Schematic Diagram)

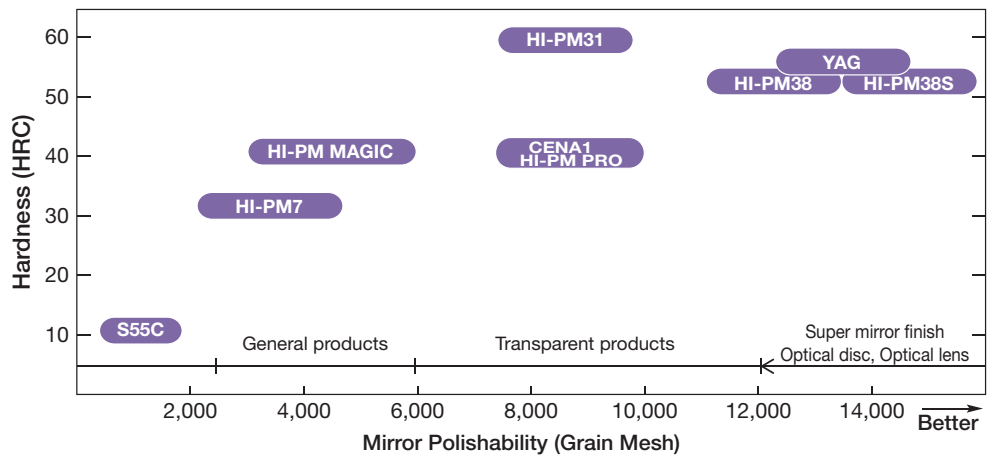

## Texturing Properties (Schematic Diagram of Uniformity by Etching)

(Remarks)  
This diagram does not show etching efficiency. (Etching efficiency is inversely proportional to the corrosion resistance.)

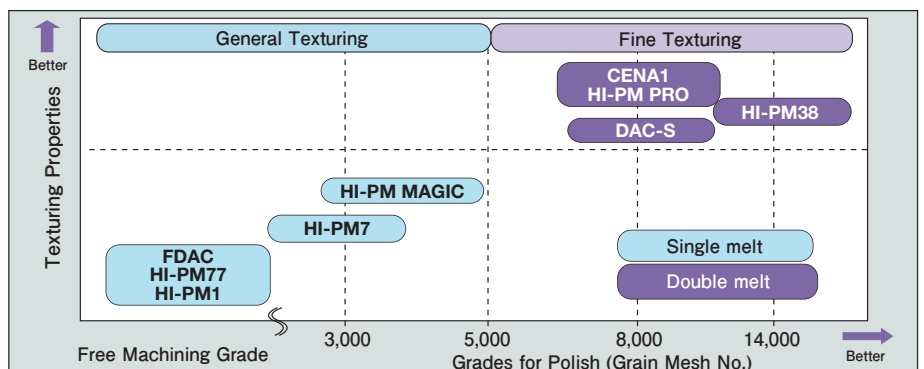

## Machinability

Drilling  
Tool: SKH51  $\phi$ 10  
Feed: 0.15mm/rev  
Depth: 30mm  
Dry

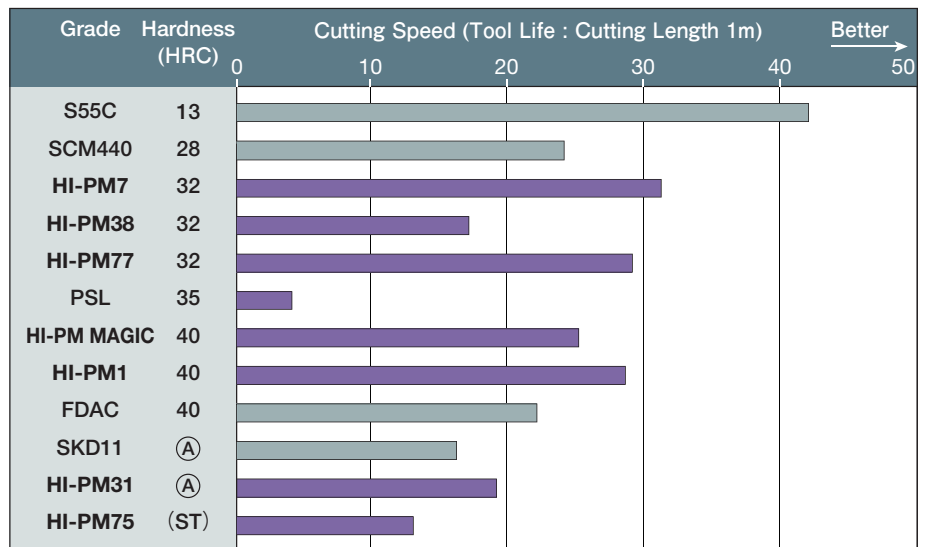

## Corrosion Resistance (5% Sulfuric Acid Solution)



<Attention> The characteristics, photos, charts, rankings and evaluations of this catalog are representative value by our test data, it does not guarantee the quality of the product. This catalog and its contents are subject to change without notice.

# Properties Comparison

## Wear Resistance

Ohgoshi-method Wear Test  
 Work Material SCM415  
 Load 67N  
 Friction Distance 400m  
 Friction Speed 0.78m/sec

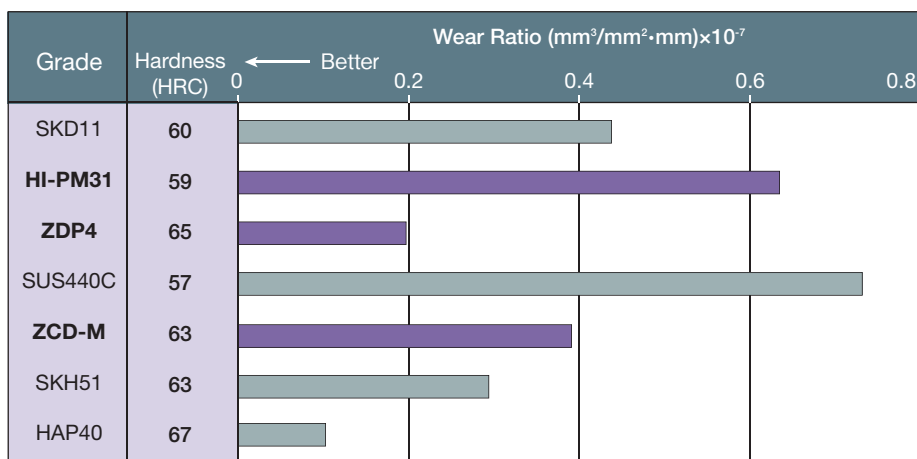

## Mechanical Properties

Grade	Hardness (HRC)	Tensile Strength (N/mm²)	0.2% Yield Strength (N/mm²)	Elongation (%)	Reduction of Area (%)	
<b>HI-PM7</b>	32	975	855	20	55	
<b>HI-PM38</b>	52	1,910	1,620	13	35	
<b>HI-PM77</b>	32	990	845	16	41	
<b>PSL</b>	39	1,170	1,100	11	34	
<b>CENA1</b>	40	1,225	1,150	15	50	
<b>HI-PM MAGIC</b>	40	1,200	1,020	18	45	
<b>HI-PM PRO</b>	40	1,200	1,020	17	45	
<b>HI-PM1</b>	40	L	1,225	1,030	18	40
	40	T	1,215	1,010	10	25
<b>HI-PM75</b>	42	1,305	1,110	11	28	
<b>YAG</b>	53	2,010	1,910	10	48	

## Physical Properties

Grade	Thermal Expansion Coef. (×10⁻⁶/°C) Averaged value from 30°C to each temp.				Thermal Conductivity (W/m·K)				
	100°C	200°C	300°C	400°C	20°C	100°C	200°C	300°C	400°C
<b>HI-PM7</b>	11.6	12.2	12.8	13.4	34.3	38.3	39.8	40.4	40.6
<b>HI-PM38</b>	10.4	11.1	11.5	11.8	22.1	25.5	26.7	28.5	29.6
<b>HI-PM77</b>	10.1	10.7	11.1	11.5	22.3	24.9	26.3	27.9	29.5
<b>PSL</b>	10.6	11.1	11.9	12.1	15.8	20.0	22.2	24.2	25.5
<b>CENA1</b>	10.8	11.5	12.0	12.4	20.5	22.9	25.9	28.2	30.5
<b>HI-PM MAGIC</b>	11.5	12.3	12.9	13.4	31.4	34.1	37.7	40.2	41.1
<b>HI-PM PRO</b>	12.7	13.0	13.3	—	28.3	31.9	35.4	38.3	—
<b>HI-PM1</b>	11.4	11.8	12.3	12.8	31.5	36.6	38.4	39.4	40.1
<b>HI-PM31</b>	12.4	13.1	13.6	14.1	26.5	—	34.4	—	39.8
<b>ZCD-M</b>	10.5	10.8	11.5	11.9	16.4	19.4	22.0	25.3	24.4
<b>HI-PM75</b>	16.1	17.2	18.0	18.6	12.3	14.5	16.4	18.7	20.4
<b>YAG</b>	—	10.8	—	—	20.9	—	25.5	—	27.6



<Attention> The characteristics, photos, charts, rankings and evaluations of this catalog are representative value by our test data, it does not guarantee the quality of the product. This catalog and its contents are subject to change without notice.

# 40HRC Prehardened Grade

## CENA1

Prehardened : 37- 41HRC  
Precipitation Hardening,  
Rust-Resisting Grade for  
Precise Mold

CENA1 is a high performance plastic mold with rust resistivity and excellent machinability. CENA1 has exceptional high purity and suits for critical surface finish.

### Features

- No heat treatment is necessary. Uniform hardness distribution. (37- 42HRC)
- Higher rust resistivity compared with P21 type grade.
- Excellent mirror polishability, crepe- and EDM finishability.
- Good weldability with least hardness elevation.
- Good nitriding hardenability and can be used for wear resisting application.

### Application

- Most suitable for weldless molding.
- Countermeasure against corrosion by gas generated from resin.
- Other critical surface finish molds. Engineering resin products.



TV Glossy Frame  
(Weldless Molding)



Non-glare Treatment Sample

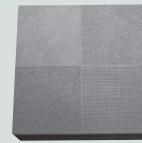

Creping Sample

## HI-PM PRO

Prehardened: 37- 41HRC  
Precipitation Hardening Grade  
for Precise Mold

HI-PM PRO is the steel for plastic molds which precisely pursues consistency in production to meet requirement for elaborately designed products.

### Features

- "Hardness" (37 to 41HRC) which is suitable for mass production of resin products by precision molding.
- "Excellent machinability for high quality appearance" supports excellent mirror polishability, creping, EDM surface (thanks to the special melting method).
- "Toughness and machinability" supports stable mold making and productivity.

### Application

- The parts associated with automobile headlight production
- The exterior of cellular phone

### Toughness

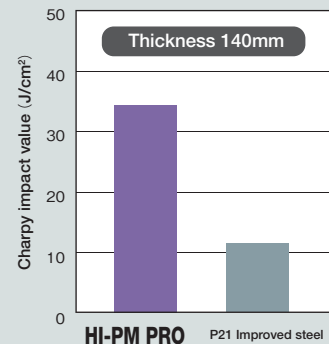

Comparison of 2mmU notch  
Charpy impact values



<Attention> The characteristics, photos, charts, rankings and evaluations of this catalog are representative value by our test data, it does not guarantee the quality of the product. This catalog and its contents are subject to change without notice.

## 40HRC Prehardened Grade

### HI-PM MAGIC

Prehardened : 37-41HRC  
Advanced Plastic Mold Steel  
for general purposes

HI-PM MAGIC is a newly developed grade which has both high durability and excellent processability. Easy weldability will make setup of the new products of home electronic, OA equipment or Auto parts smoother.

#### Features

- No heat treatment is necessary (37-41HRC)
- Stable polishability
- Steady machinability. Fits for high-speed high feed cutting
- Higher toughness compared with conventional 40HRC grades
- Easy Weldability
- Good EDM finishability
- Excellent nitriding properties
- Satisfying Cost Performance

#### Application

- General resin products for home electronics, equipment OA Auto and so on.

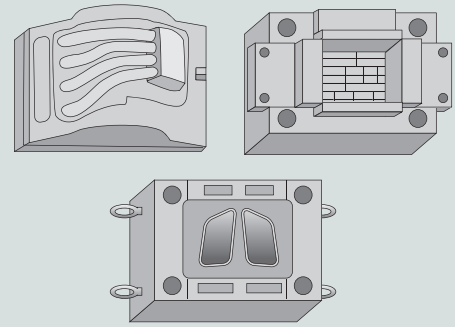

Home electronics, OA equipment, Auto parts

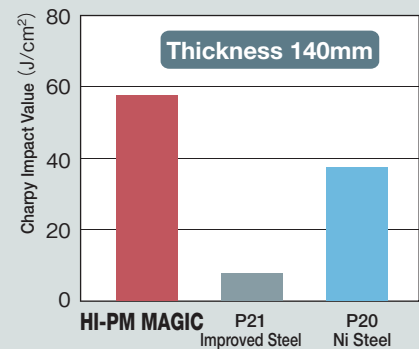

Comparison of 2mmU notch Charpy impact values (example of measurement by our company)

### HI-PM1

Prehardened : 37-41HRC  
Free Machining Precipitation  
Hardening Grade for Precise Mold

HI-PM1 is free machining plastic mold steel prehardened to 40HRC. With superb machinability, HI-PM1 is fitted for general applications.

#### Features

- No heat treatment is necessary. (37-41HRC)
- Excellent machinability among 40HRC prehardened grades.

#### Application

- General Plastic Products
- Precise Rubber Mold, etc. For Smooth Cut Surface.

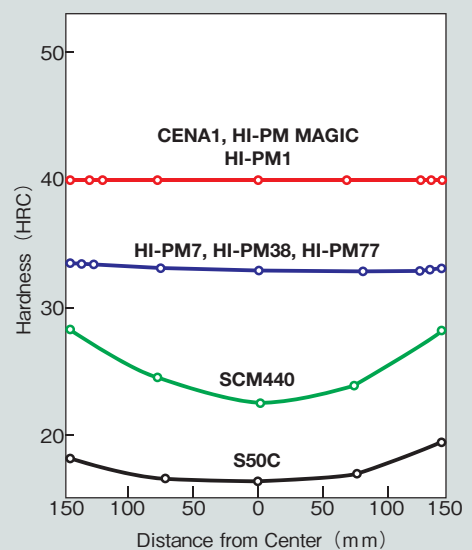

Cross Section Hardness Distribution (300mm Square Size)



<Attention> The characteristics, photos, charts, rankings and evaluations of this catalog are representative value by our test data, it does not guarantee the quality of the product. This catalog and its contents are subject to change without notice.

# 32HRC Prehardened Grade

## HI-PM7

Prehardened: 29-33HRC  
For Medium and Large Mold  
for General Application

HI-PM7 is a plastic mold steel prehardened to 29-33HRC fitted for medium and large size mold, having good machinability and weldability. In addition, it has good mirror polishability and EDM machinability to make itself one of the best steel in this class grade.

### Features

- Uniform hardness distribution even in large crosssection. (29-33HRC)
- Machinability is better than P20 or free machining steel.
- Excellent weldability with least hardness elevation.
- Stable mirror polishability.
- Less streak texture and least hardness elevation on EDM surface make finishing easier.
- Excellent toughness.
- Excellent nitriding property.

### Application

- Auto parts: Headlamp, Tail lamp, Inner panel, etc.
- Home electronics, OA equipment, House equipment: TV cabinet, Air conditioner, etc.
- Other large daily goods, Large container, Pipe, Rubber

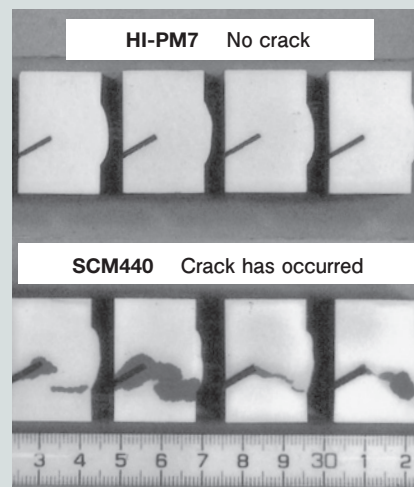
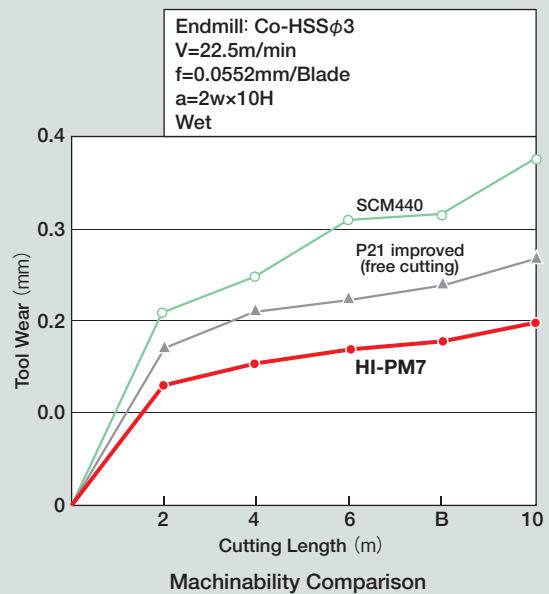
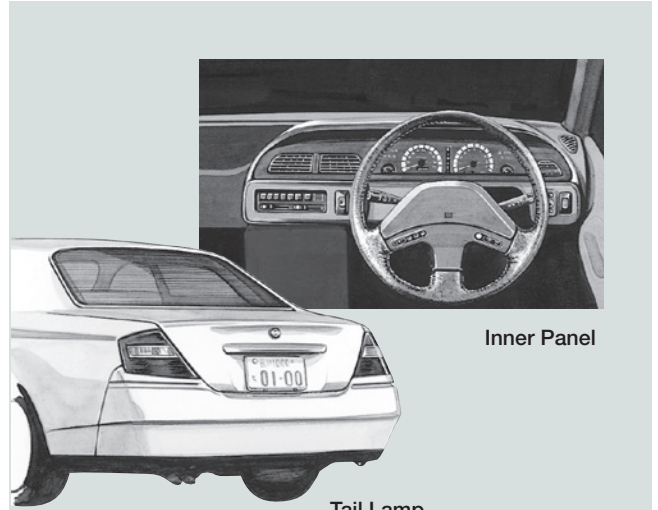

y-groove Weld Crack Test  
JIS Z 3158  
TIG Welding  
No pre-heating / No post-heating



<Attention> The characteristics, photos, charts, rankings and evaluations of this catalog are representative value by our test data, it does not guarantee the quality of the product. This catalog and its contents are subject to change without notice.



# Stainless Steel for Quench and Temper

## HI-PM38

Prehardened : 29-33HRC  
 Hardenable to : 50-55HRC  
 For Anti-Corrosion and Mirror Polish Mold

HI-PM38 is Mo contained 13Cr martensitic stainless steel prehardened to 29-33HRC, manufactured by consumable electrode remelting method, further hardenable to 50-55HRC. It is fitted for molds which require corrosion resistance and superb mirror polishability. In addition, it suits for precise heat treatment. Excellent corrosion resistance also makes mold storage easier.

### Features

- Excellent mirror polishability
- Better corrosion-resistivity than 420. Chromium plating is not necessary.
- Least heat treatment deformation, best fitted for precise mold.
- As HI-PM38 is supplied as prehardened condition, it can be used without further heat treatment also.

### Application

- Transparent items: Lense, Container for cosmetics, etc.
- Flame retardant resin products: Home electronics, OA equipment
- For omitting plating: Food container, Medical instruments

### Heat Treatment

- Quenching : 1,000-1,050°C Air Cooling
- Tempering : 200-500°C Air Cooling

## HI-PM38S

Prehardened : 29-33HRC  
 Hardenable to : 50-55HRC  
 For Super Mirror Polish Mold

### Features

- Superior mirror polishability to below 0.01 $\mu$ m surface roughness.
- Other features are same as HI-PM38.
- CD, DVD, and optical lens.

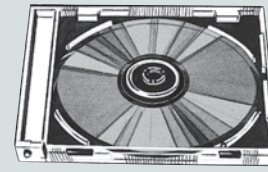

CD, DVD

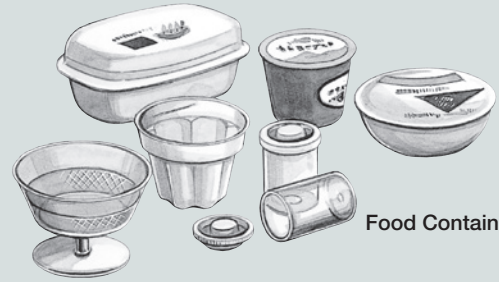

Food Container

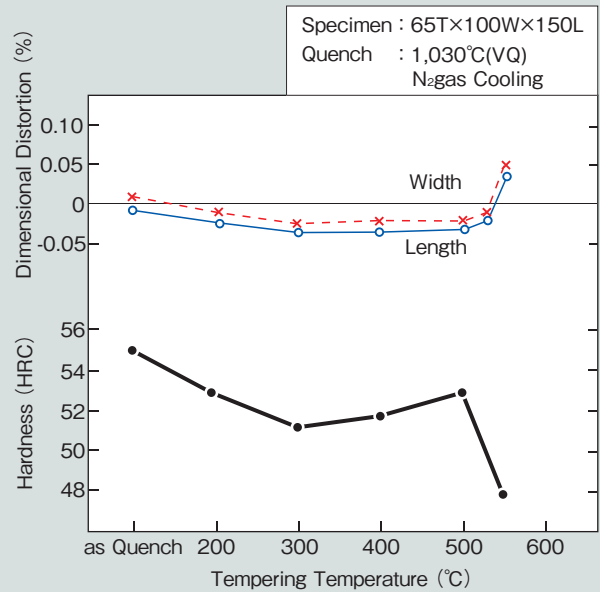

Heat Treatment Properties of HI-PM38

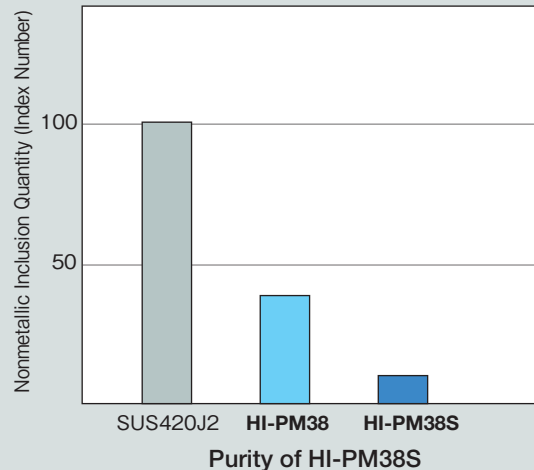

Purity of HI-PM38S



<Attention> The characteristics, photos, charts, rankings and evaluations of this catalog are representative value by our test data, it does not guarantee the quality of the product. This catalog and its contents are subject to change without notice.

# Prehardened Stainless Grade

## PSL

Prehardened :  
 33-37HRC (Flat bar)  
 38-42HRC (Round bar)  
 For Higher Grade  
 Anti-Corrosion Mold

PSL is precipitation hardening stainless steel which shows superior corrosion resistance as used for corrosive gas yielding resins or resins with flame retardant additives without plating.

### Features

- Best corrosion resistance among plastic mold steels. Plating is not needed.
- Least hardness elevation on EDM or welded surface and easier finishing jobs.

### Application

- Polyvinyl chloride : Pipe fittings, Pipe, Sash, etc.
- Resins with flame retardant additives
- Precision mold for rubber



PVC Extruded Products

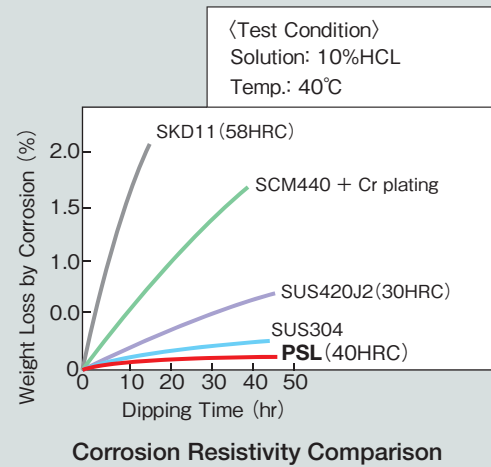

## HI-PM77

Prehardened : 29-33HRC  
 Free Machining Martensitic  
 Stainless Grade for Mold Base

### Features

- Good corrosion resistance and well fitted for rust protection of water cooling holes or surface of mold base.
- Excellent machinability
- Prehardened and good mechanical properties

### Application

- Holder for compact disc mold or lens mold.
- Holder for food or medical container mold and precise engineering resin mold.
- Mold for rubber
- Anti-corrosive support tools

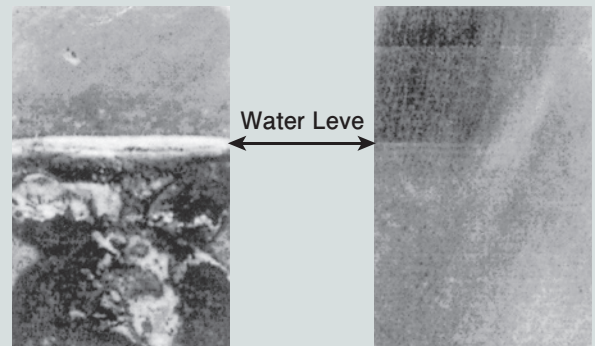

S55C

HI-PM77

Rust after 1 month dipping in water



<Attention> The characteristics, photos, charts, rankings and evaluations of this catalog are representative value by our test data, it does not guarantee the quality of the product. This catalog and its contents are subject to change without notice.

# High Wear Resistance Grade

## HI-PM31

Hardenable to : 55-60HRC  
High Wear Resistant Grade  
for Mass Production

HI-PM31 is wear resistant plastic mold steel with fine carbide uniformly distributed by means of appropriate alloy design and consumable electrode remelting process. Least heat treatment distortion, it suits for precise heat treatment.

### Features

- Wear resistance is as high as JIS SKD11.
- Much better machinability and grindability than JIS SKD11.
- Least heat treatment deformation, best fitted for precise mold.
- Good mirror polishability crepe and EDM finishability
- High hardness and toughness, enough against chipping or breakage

### Application

- Engineering resin products and thermosetting resin products
- Precise mold: IC mold, Connector, Watch parts, Camera parts

### Heat Treatment

- Quenching : 1,000-1,050°C Air Cooling
- Tempering : 200-550°C Air Cooling

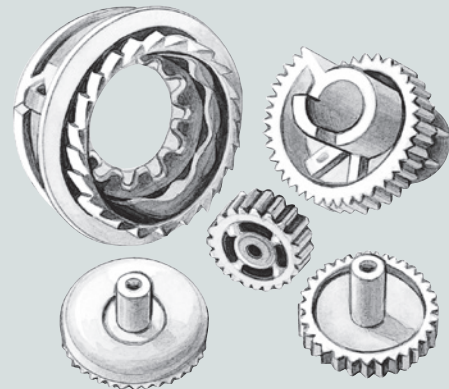

Engineering Resin Gear

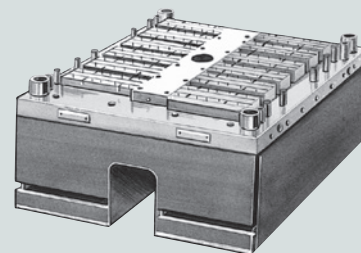

IC Mold

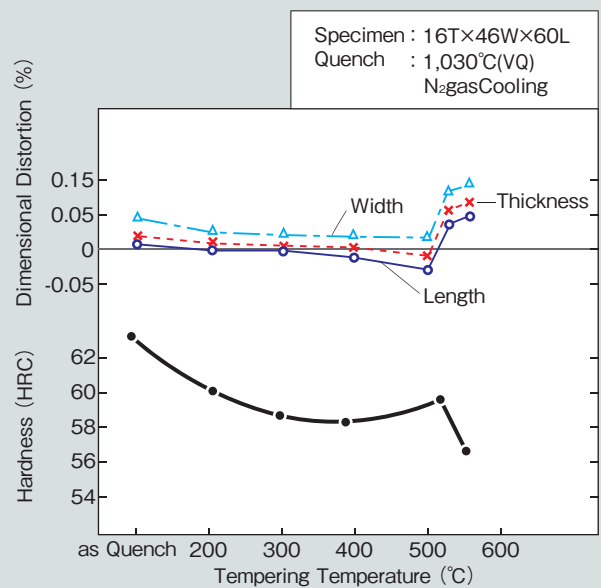

Heat Treatment Properties of HI-PM31



<Attention> The characteristics, photos, charts, rankings and evaluations of this catalog are representative value by our test data, it does not guarantee the quality of the product. This catalog and its contents are subject to change without notice.

# Aging Grade

## YAG

Hardenable to : 52-57HRC  
Super High Toughness  
Maraging Steel

As YAG is delivered as solution heat treated condition, you are advised to conduct aging at 480-520°C in order to get hardness between 52-57HRC after engraving cavity.

(Remarks)  
This product might correspond to the Export Trade Control Order. When you export this product, you might need apply for export licenses to the authorities in your country.

### Features

- Excellent toughness and mechanical properties under high hardness and best fitted against breakage
- Super mirror polishability
- Hardness of 55HRC is obtainable by aging at 500°C with least distortion

### Application

- Optical lens
- Thin core pin
- Ejector pin, either of small diameter or of long length

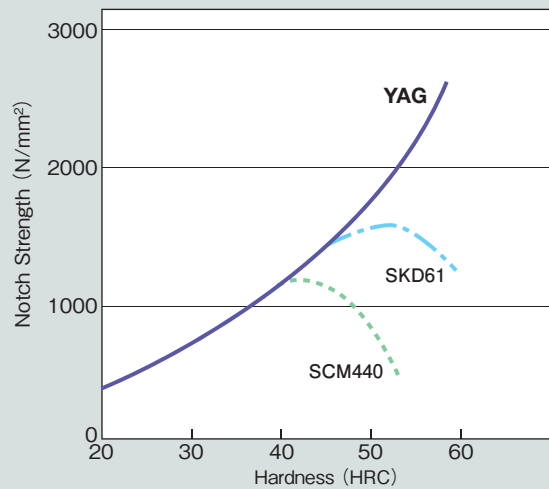
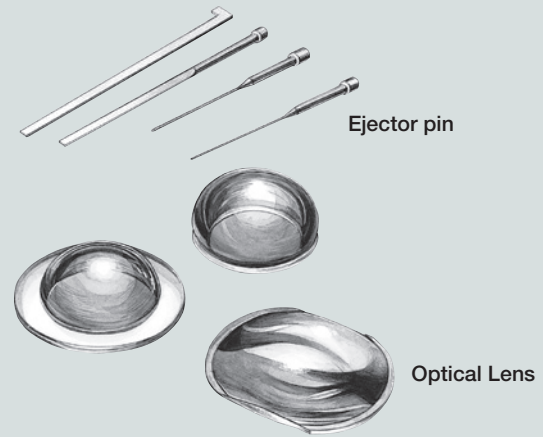

Relationship between Hardness and Notch Strength

## HI-PM75

Hardenable to : 35-45HRC  
Non-Magnetic High Hardness  
Free Machining Plastic Mold  
Steel

### Features

- Permeability( $\mu$ ) is 1.01, equally non-magnetic as 304
- 35-45HRC is obtainable by aging of 700°C×5h and has higher wear resistance.
- Good nitriding properties

(Remarks)  
Slower machining recommended as it is easily hardened by machining.

### Application

- Plastic magnet
- Wear resistant, non-magnetic supportive tools



<Attention> The characteristics, photos, charts, rankings and evaluations of this catalog are representative value by our test data, it does not guarantee the quality of the product. This catalog and its contents are subject to change without notice.

# Higher Grade Polishing Method of Plastic Mold

## Polish procedure Example

● Polish by oil grinding stone (use kerosene) -----	#180→#240→#320→#400→#600→#800
● Polish by oil sand paper (use kerosene) -----	#600→#800→#1000→#1200→#1500
● Finish Polishing by diamond compound (use felt cloth)	#1800→#3000→#8000→#14000 (9μm) (6μm) (3μm) (1μm)

## Important points of polishing

1. Each procedure is to be strictly kept.
2. When changing from one number to another, check if there are remained scratches by changing polishing direction. (move 45-90 degrees)
3. When changing numbers, wash and remove last polishing grains completely.
4. Polishing by diamond compound needs to be done in short times. Excessive polish can produce pinholes or orange peel.
5. Avoid alumina and chromium oxide as the polish capabilities are lower than diamond.
6. During long interruption, the object must be protected from the rust.

## Remarks:

- A. For superior polishing use diamond compound.  
Don't use alumina nor chromium-oxide compound.



Diamond Compound Finish

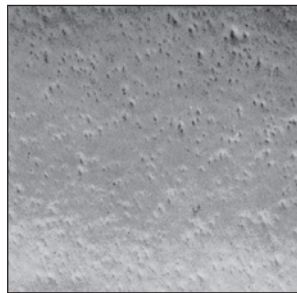

Aluminium Oxide Finish Not Good

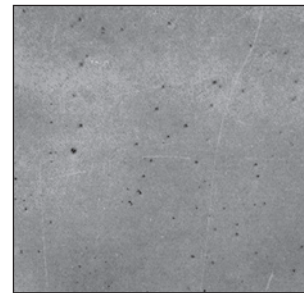

Chromium Oxide Finish Not Good

- B. Load for polishing should be kept the lowest possible.  
C. Foregoing polish should be done prudently.  
D. Rust proof measures must be taken in any interruption of jobs.



Scratch remains due to overload.



Seam and pinhole texture at crossing by less foregoing polish

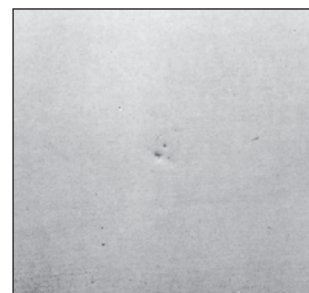

Pinhole texture by inappropriate rust proof.



<Attention> The characteristics, photos, charts, rankings and evaluations of this catalog are representative value by our test data, it does not guarantee the quality of the product. This catalog and its contents are subject to change without notice.

# Welding of Plastic Mold

## Attentive points

### 1. Preparations before welding

- A. Form of location to get welded should be made smooth as Figure 1.
- B. Cracks and treated surface (nitrided or plated) must be eliminated.
- C. Oil, dust, moisture and scale must be removed thoroughly.

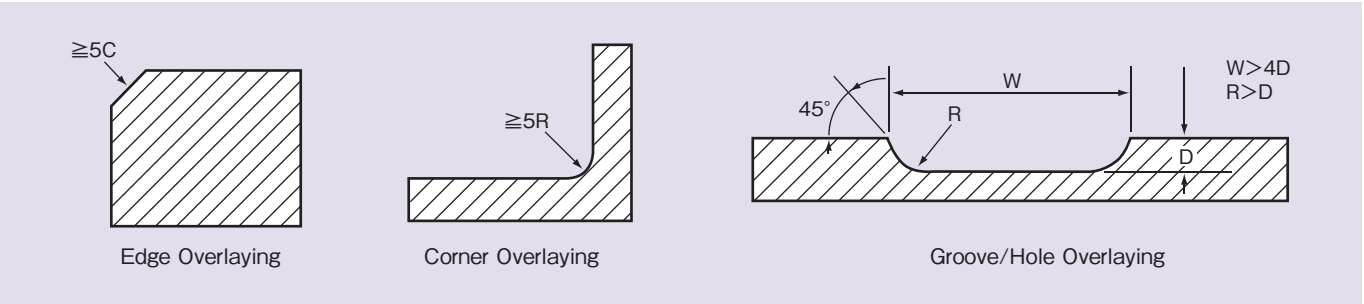

Figure 1. Standing shapes for build up welding

### 2. Welding rod

- A. Welding rod of similar composition as mold is to be used so that welding may not bring about unevenness of mirror finish or creping surface.  
When the mold is made from HI-PM MAGIC, use welding rod made from HI-PM MAGIC-W. Likewise, in case fo TIG welding there are T-HTM-31 and T-HTM38 in the market for welding for mold made from HI-PM31 and HI-PM38.
- B. In case of using coated electrode, welding rod should be dried by heating to 250-300°C before using.
- C. For cavity welding, TIG welding should be applied.  
(TIG : Tungsten Inert Gas)

### 3. Welding

- A. Figure 2 shows example of actual welding jobs of representative grades.
- B. Tempering should be conducted soon after welding in case of prehardened steel or hardened and tempered steel according to Figure 2.  
Tempering is effective to protect mold from crack and to stabilize mirror finish and creped surface by having uniform hardness and structure.

Mold Steel Grade	Welding	Welding Rod	Condition	Heat Cycle
HI-PM MAGIC	TIG	HI-PM MAGIC-W	<ul style="list-style-type: none"> <li>●TIG Welding</li> <li>Rod                      Current</li> <li>{ 2.4φ .....       80-160A</li> <li>  3.2φ .....       110-200A</li> <li>Flow Rate 10-15l/min</li> </ul>	<p>(Stress relieving for correcting deformations and precise creping)</p>
HI-PM7	TIG	HI-PM7-W	<ul style="list-style-type: none"> <li>●Shielded Metal Ark Welding</li> <li>Rod                      Current</li> <li>{ 3.2φ .....       90-120A</li> <li>  4.0φ .....       130-160A</li> </ul>	

Figure 2. Welding procedure



<Attention> The characteristics, photos, charts, rankings and evaluations of this catalog are representative value by our test data, it does not guarantee the quality of the product. This catalog and its contents are subject to change without notice.

## **Hitachi Metals, Ltd.**

**Head Office** SEAVANS North Building, 1-2-1, Shibaura, Minato-ku, Tokyo 105-8614, Japan  
High-Grade Metals Company  
Tel. +81-3-5765-4410  
Fax. +81-3-5765-8317

## **Hitachi Metals America, Ltd.**

**Head Office** 2 Manhattanville Road, Suite 301, Purchase, NY 10577, U.S.A.  
Tel. +1-914-694-9200  
Fax. +1-914-694-9279

**Other Office** Chicago, Detroit, Pittsburgh, San Jone, Novi Michigan

## **Hitachi Metals Europe GmbH**

**Head Office** Immermannstrasse 14-16, 40210 Duesseldorf, Germany  
Tel. +49-211-16009-0  
Fax. +49-211-16009-29

**Other Office** London, Milano, Paris

## **Hitachi Metals Singapore Pte. Ltd.**

12 Gul Avenue, Singapore 629656  
Tel. +65-6861-7711  
Fax. +65-6861-1519

## **Hitachi Metals (Dong Guan) Specialty Steel Co., Ltd.**

**Head Office** Cha Shan Town, Dong Guan City, 522380, China  
Tel. +86-769-8640-6726  
Fax. +86-769-8640-6716

**Shanghai Branch** No.155 jiu yuan road, Qingpu industrial zone, Qingpu District, Shanghai, 201712, China  
Tel. +86-21-3929-2202  
Fax. +86-21-3929-2201

**Tianjin Jinnan Branch** No.11, Jianshe 4th Branch Road, Balitai Town, Jinnan District, Tianjin, 300350, China  
Tel. +86-22-8699-3101/3102  
Fax. +86-22-8699-3103

**Dalian Branch** 3<sup>#</sup>-2, Koushin Mould Industrial Park III B-1-1-1F. T. Z. Dalian, 116600, China  
Tel. +86-411-8718-1011/1022  
Fax. +86-411-8718-1033

## **Hitachi Metals (Suzhou) Technology, Ltd.**

88 Xing jin Street, Suzhou Industrial Park, Jiangsu Province, 215027, China  
Tel. +86-512-6790-2106  
Fax. +86-512-6790-2128

- The characteristics listed on this catalog are representative values and they do not guarantee the quality of the product.
- This catalog and its contents are subject to change without notice.
- Do not duplicate this catalog without a permission from Hitachi Metals, Ltd.
- Please contact a representative of our Specialty Steel Division if there are any questions or problems.

Our address and contact indicated in this catalog are those as of January 2015.  
If you cannot put a call through, please contact our Corporate Communications Office in Tokyo below.

Hitachi Metals, Ltd.  
Corporate Communications Office  
Tel: +81-3-5765-4076 Fax: +81-3-5765-8312

