

800 / 900 MHz Band Chip 0 deg. Splitter / Combiner

Model No. FSTH-01R-3

Equivalent Circuits

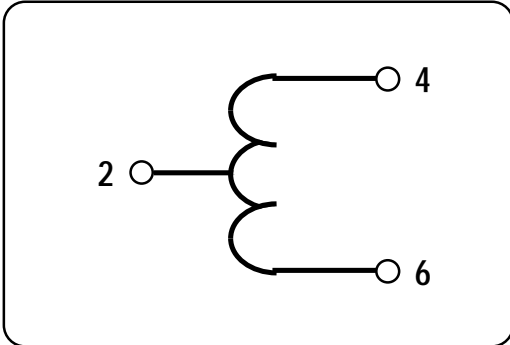

Shape & Size

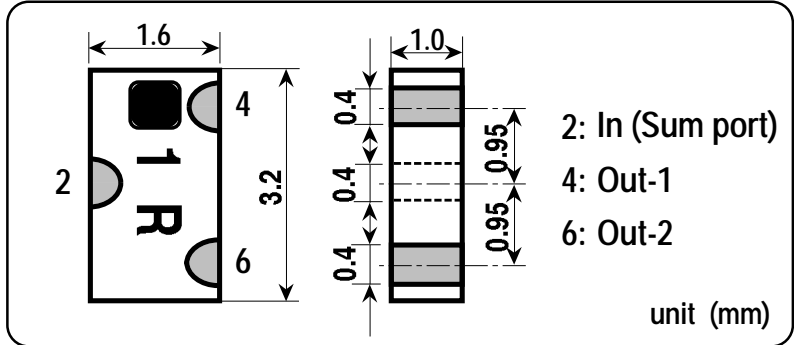

Specifications

P/N	Frequency Range(MHz)	Matching Capacitor	Insertion Loss	Isolation	Return Loss	Handling Power	Temp. Range
FSTH-01R-1	700-900	3.0pF	1dB Max. (0.2dB Typ.) *1	12dB Min. (20dB Typ.)	9.5dB Min. (17.7dB Typ.)	1W Max.	-35 ~ +85 deg.C
FSTH-01R-2	850-950	2.5pF					
FSTH-01R-3	900-1100	2.0pF					

\*1 Not include Splitting Loss (3dB)

Measurement Circuit

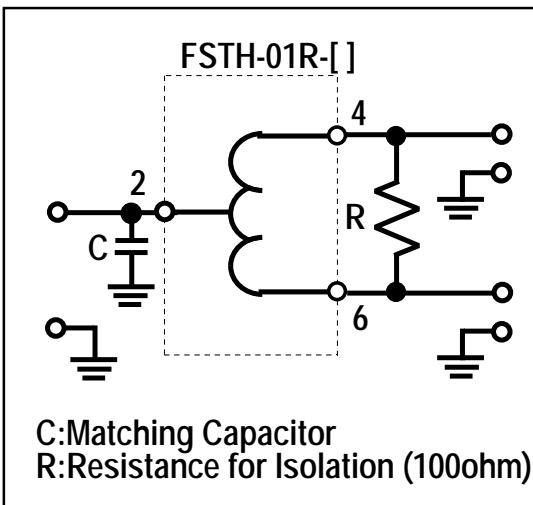

Typical Data

