

# 7mm SQUARE THIN TYPE ISOLATOR

## MODEL ESI-7SG [ ] 1.862 G 02 - T

(1) (2) (3) (4) (5) (6)

(1) Series ESI-7SG ; 2.5mm Height

(2) Rotating Direction (R or L)

(3) Center Frequency

(4) G ; GHz

(5) Control No.

(6) T ; Taping

Blank ; Bulk

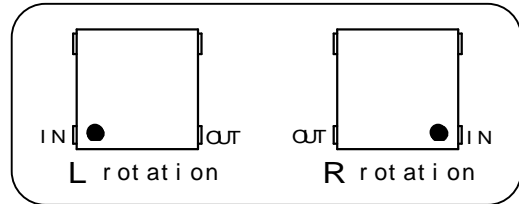

### Specification

Frequency (GHz)	Ins. Loss Max. (dB)	Isolation Min. (dB)	V.S.W.R. Max.	Attenuation		Handling Power Max. (W)	Reflection Power Max. (W)
				at 2f	at 3f		
				Min. (dB)	Min. (dB)		
1.845-1.880	0.60	15	1.5	5	15	5.0	1.0

Operating Temperature(deg.C) ; -35 to +85

Impedance ; 50 ohms Typ.

Applicable to Pb free reflow soldering

### Shape & Size

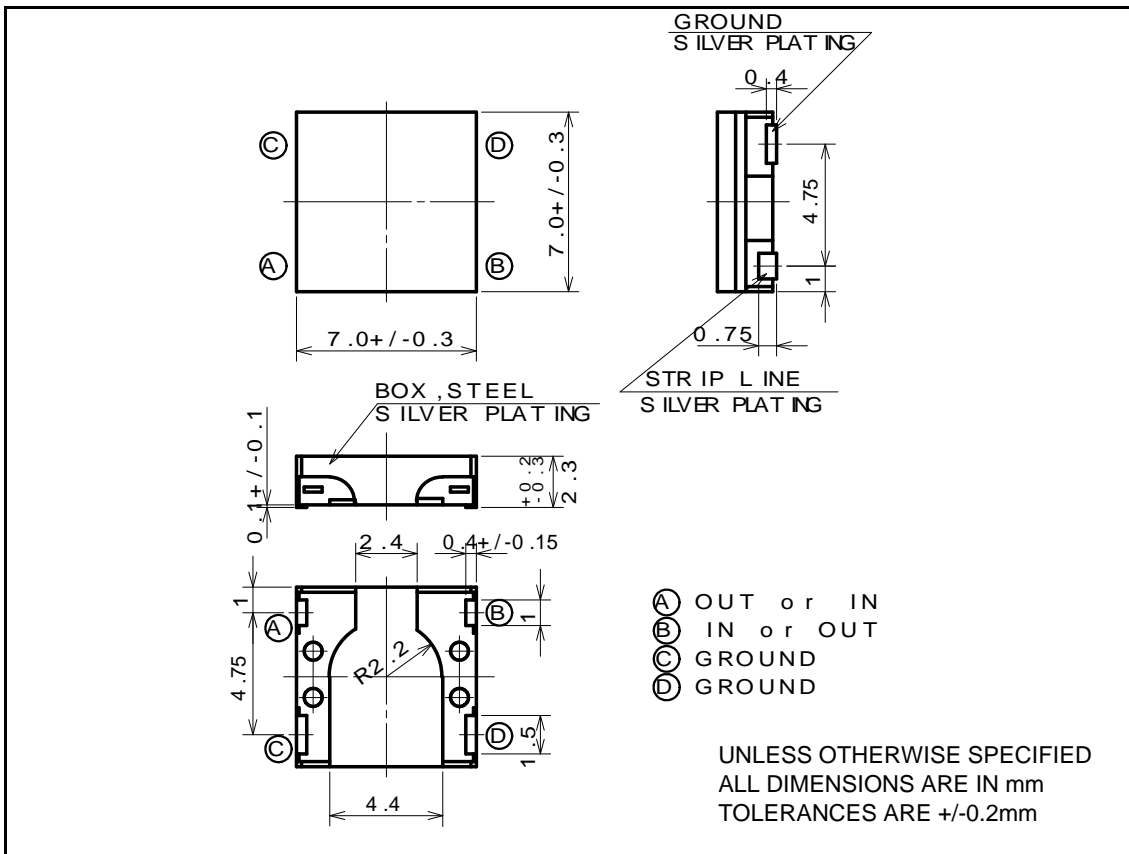

TBE345