

7mm SQUARE THIN TYPE ISOLATOR

MODEL ESI-7SG [] 1.747 G 02 - T

(1) (2) (3) (4) (5) (6)

(1) Series ESI-7SG ; 2.5mm Height

(2) Rotating Direction (R or L)

(3) Center Frequency

(4) G ; GHz

(5) Control No.

(6) T ; Taping

Blank ; Bulk

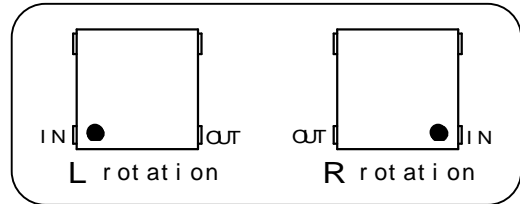

Specification

Frequency (GHz)	Ins. Loss Max. (dB)	Isolation Min. (dB)	V.S.W.R. Max.	Attenuation		Handling Power Max. (W)	Reflection Power Max. (W)
				at 2f	at 3f		
				Min. (dB)	Min. (dB)		
1.710-1.785	0.60	15	1.5	5	15	5.0	1.0

Operating Temperature(deg.C) ; -35 to +85

Impedance ; 50 ohms Typ.

Applicable to Pb free reflow soldering

Shape & Size

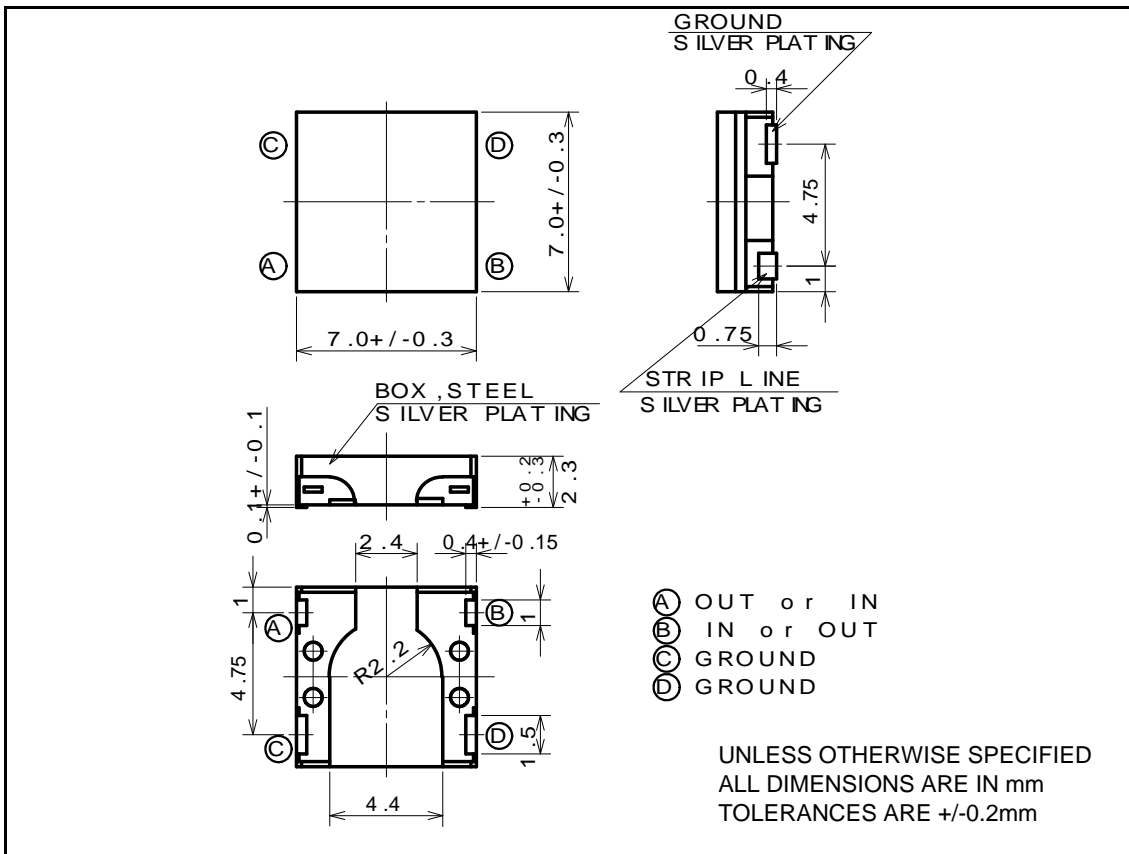

TBE025