

4mm SQUARE THIN TYPE ISOLATOR

MODEL ESI-4AG [] 1.855 G 01 - T

(1) (2) (3) (4) (5) (6)

- (1) Series ESI-4AG ; 1.6 +/-0.1mm Height
- (2) Rotating Direction (R or L)
- (3) Center Frequency
- (4) G ; GHz
- (5) Control No.
- (6) T ; Taping
Blank ; Bulk

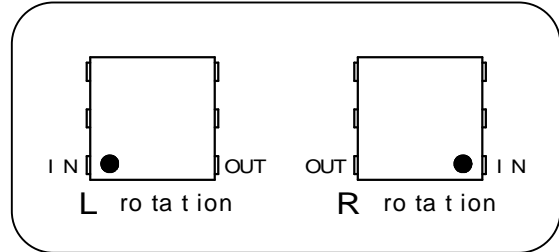

Specification

Frequency (GHz)	Ins. Loss Max. (dB)	Isolation Min. (dB)	V.S.W.R. Max.	Attenuation		Handling Power Max. (W)	Reflection Power Max. (W)
				at 2f Min. (dB)	at 3f Min. (dB)		
1.840-1.870	0.50	15	1.5	13	15	5.0	1.0

Operating Temperature(deg.C) ; -35 to +85

Impedance ; 50 ohms Typ.

Shape & Size

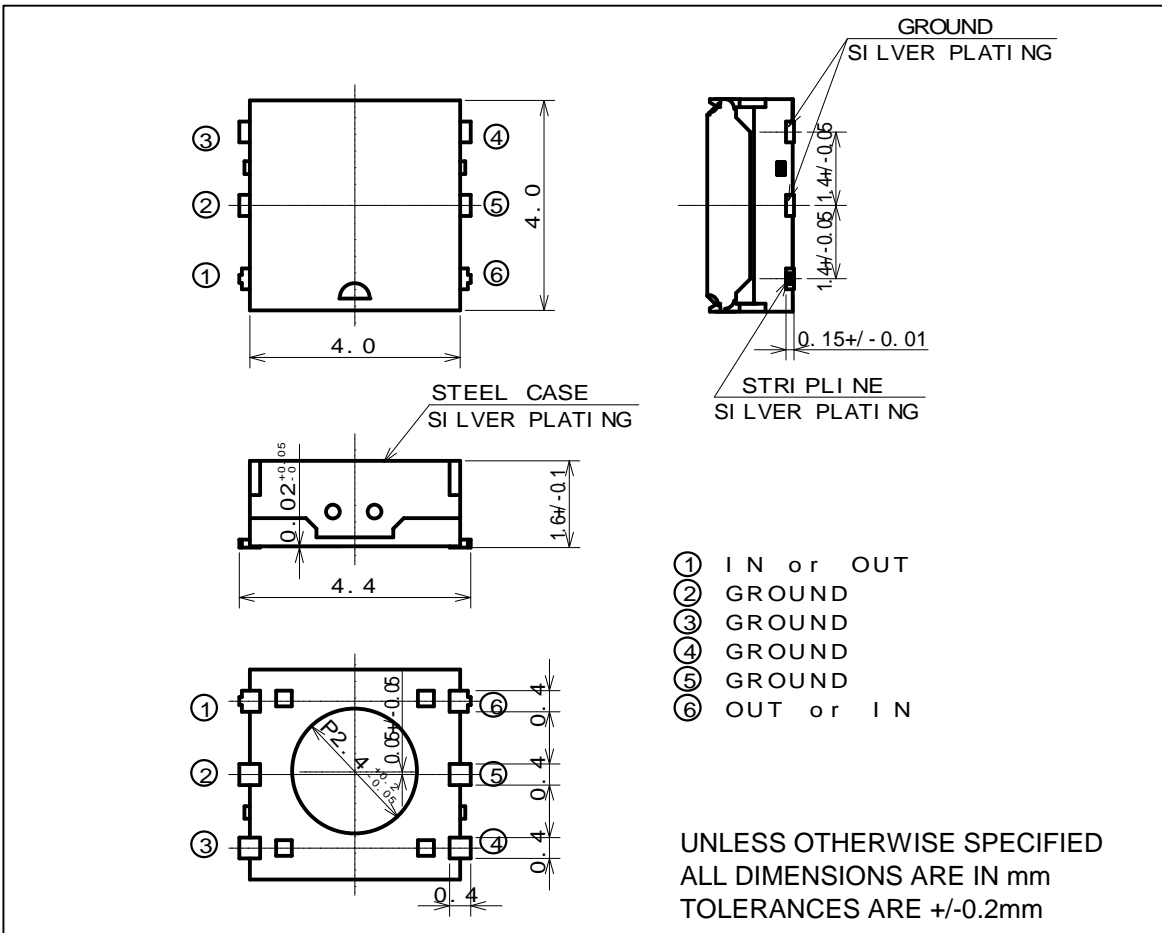

TAE823