

◇ 22mm Square Isolator ◇

CAT-266

Part No. MSI-22BR1.843G

Specifications

Frequency	1805 ~ 1880 MHz
Band Width	Full
Insertion Loss	0.3 dB max
Isolation	20 dB min
V.S.W.R	1.20 max
Handling Power	200 W max (P-P 400W max)
Reflection Power	70 W max
Operating Temp.	-20 ~ +80 °C
Impedance	50 Ω
Intermodulation 3rd order	70 dBc max at 46dBmX2tones

Dimensions

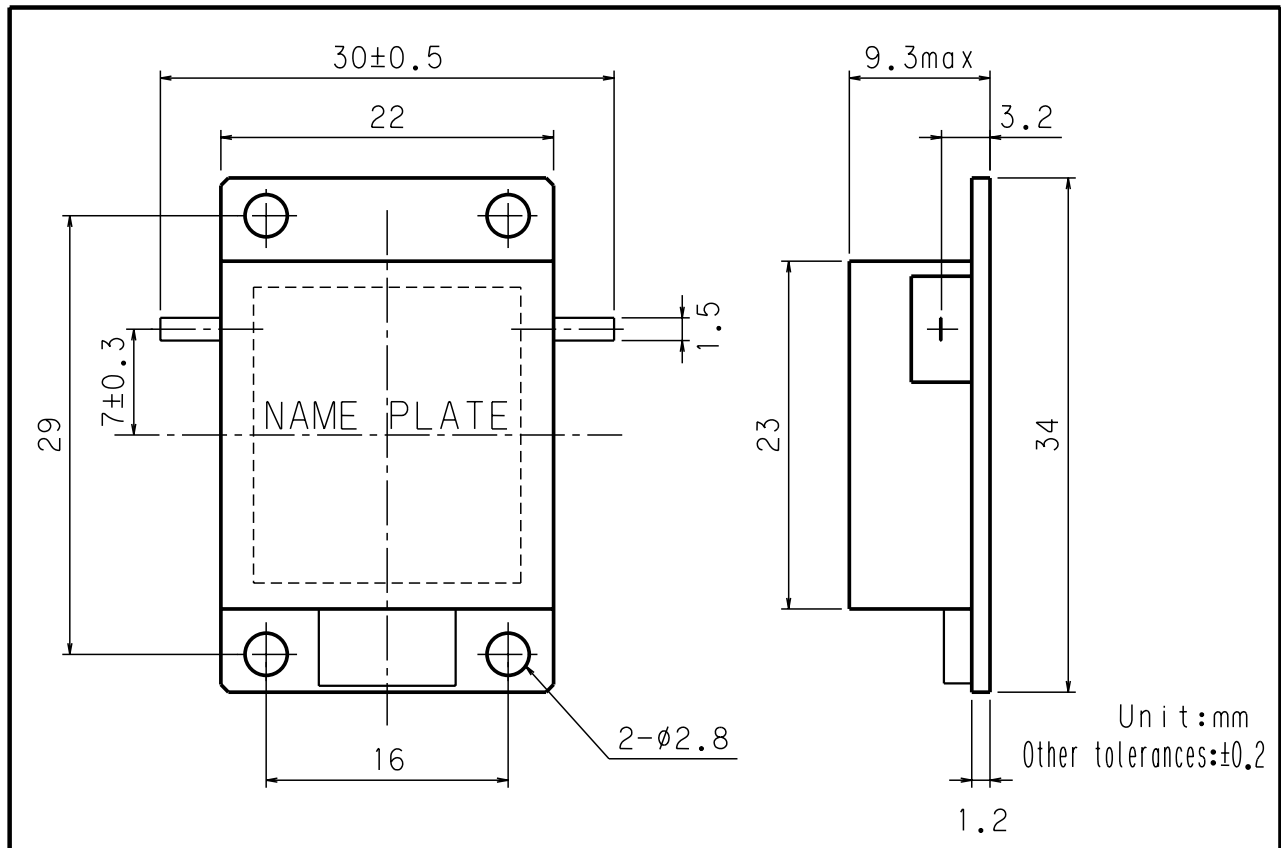

Hitachi Metals, Ltd.