



SMD Isolator



Part No. DSI-22R1.842G

CAT-233

● Specifications

Frequency	1805 - 1880 MHz
Band Width	Full
Insertion Loss	0.35 dB max
Isolation	22 dB min
V.S.W.R	1.20 max
Handling Power	30 W max
Refraction Power	10 W max
Operating Temp.	-10 - +85 °C
Impedance	50 Ω

● Dimensions

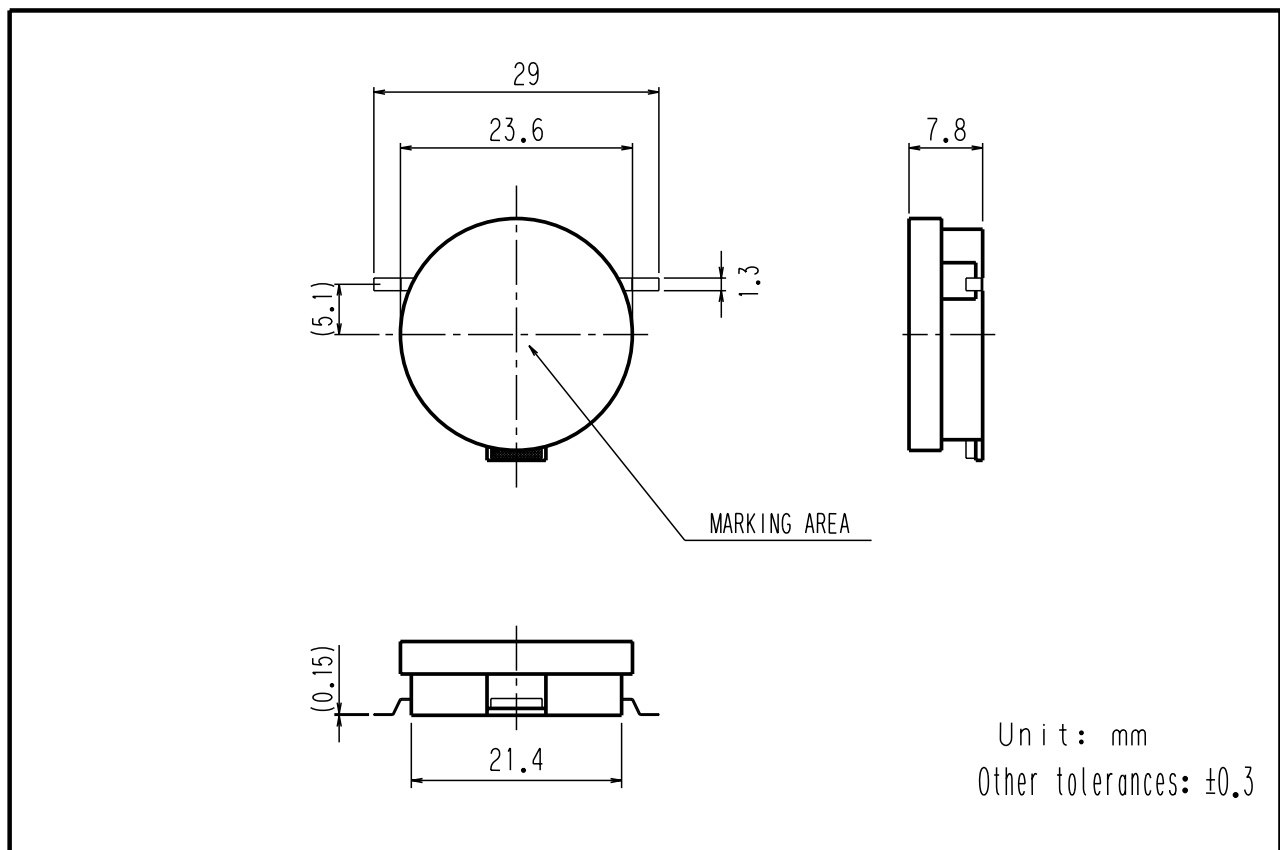

Hitachi Metals, Ltd.